

Assembly instructions "Omega"

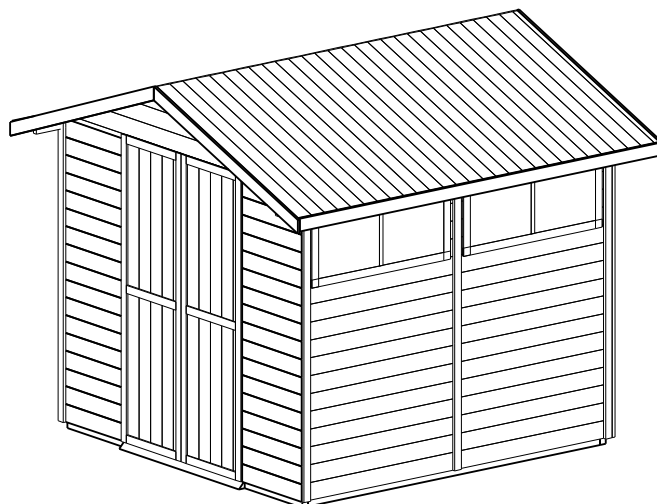

1st step
Base
43x43mm

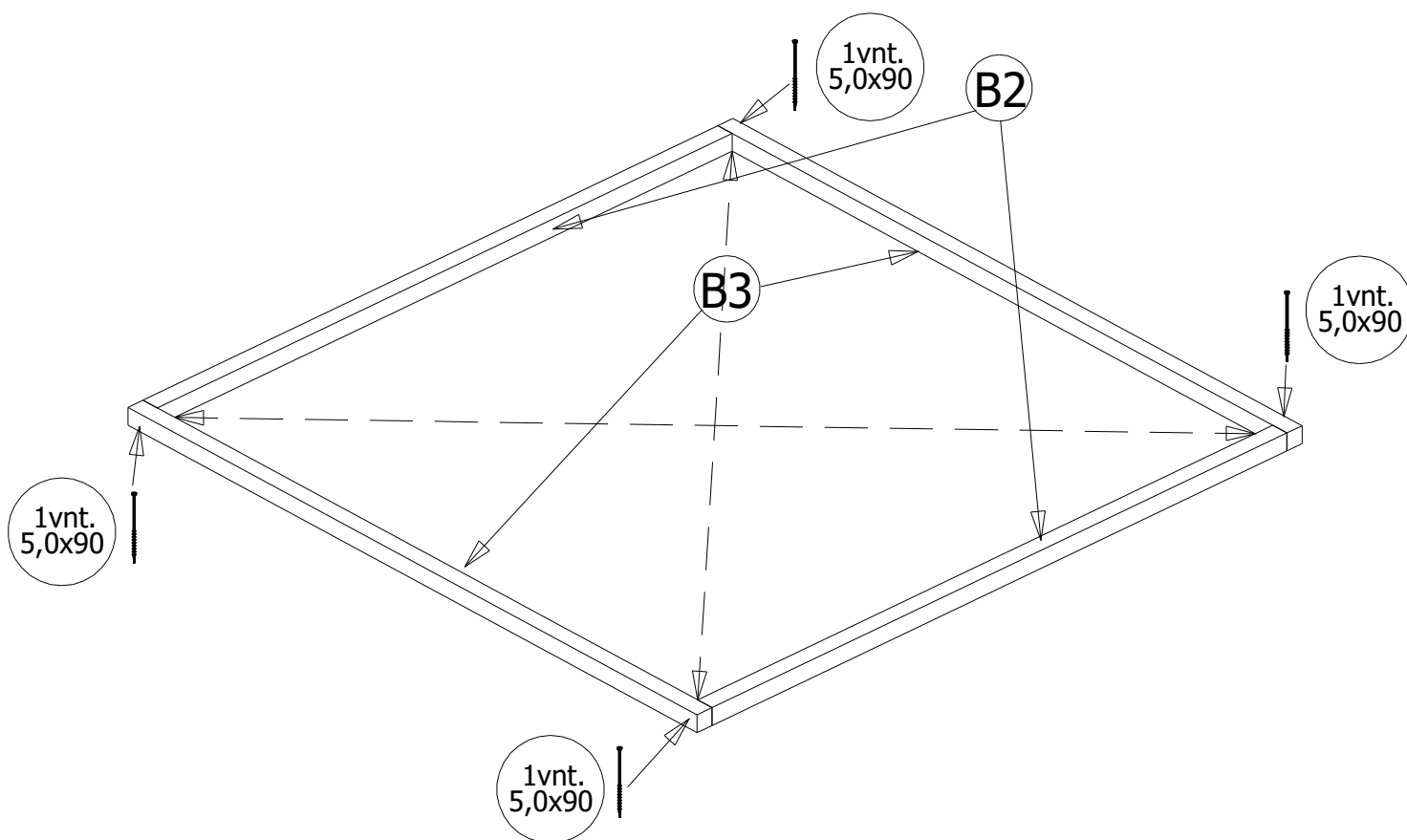

2nd step Wall panel assembly

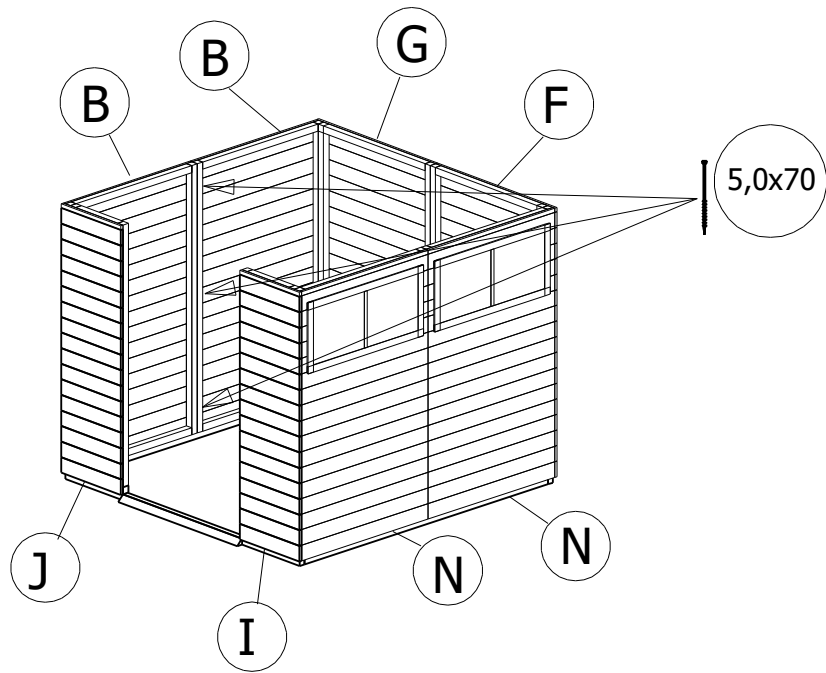
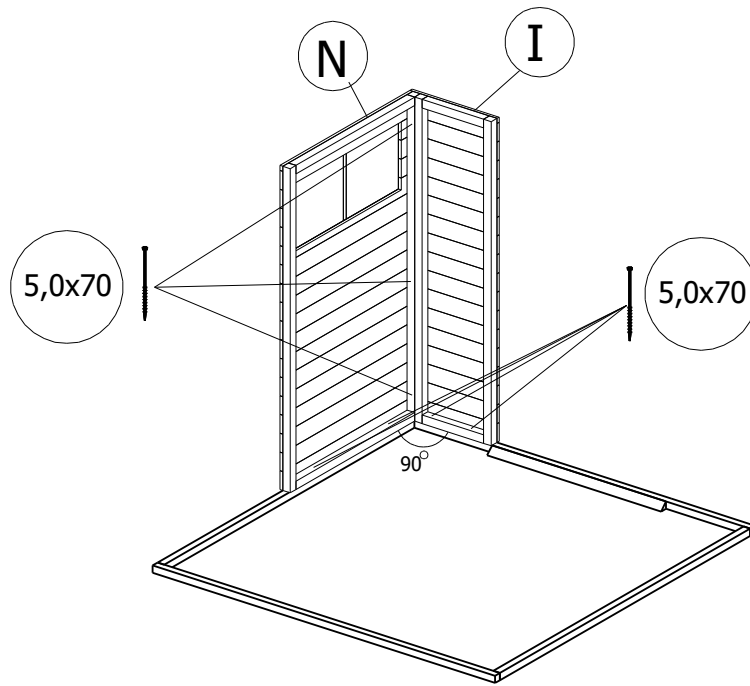

3rd step
Roof assembly

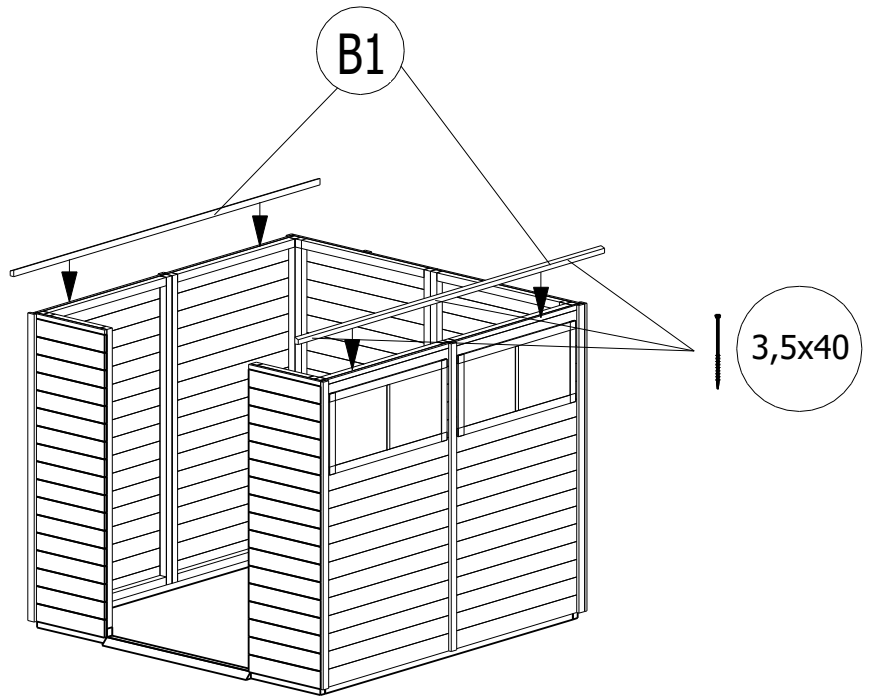

3rd step Roof assembly

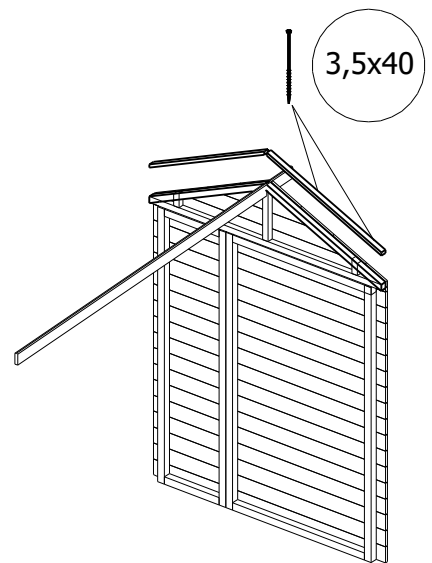
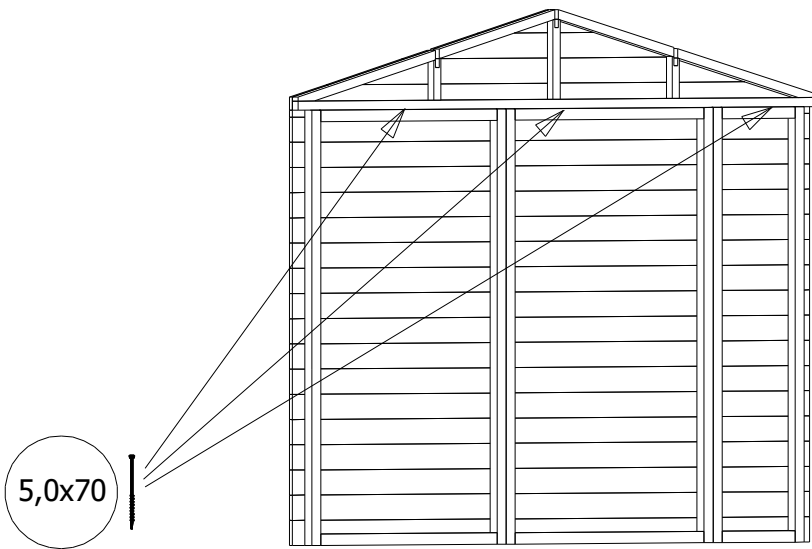
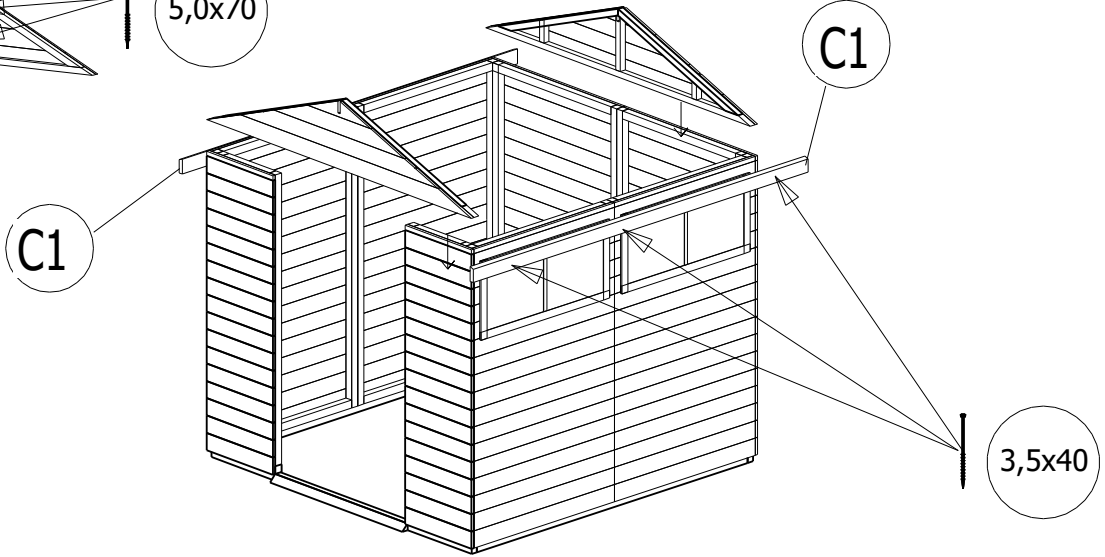
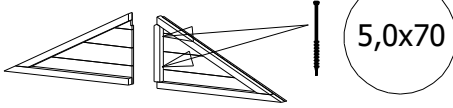
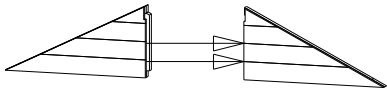

Roof assembly

C2

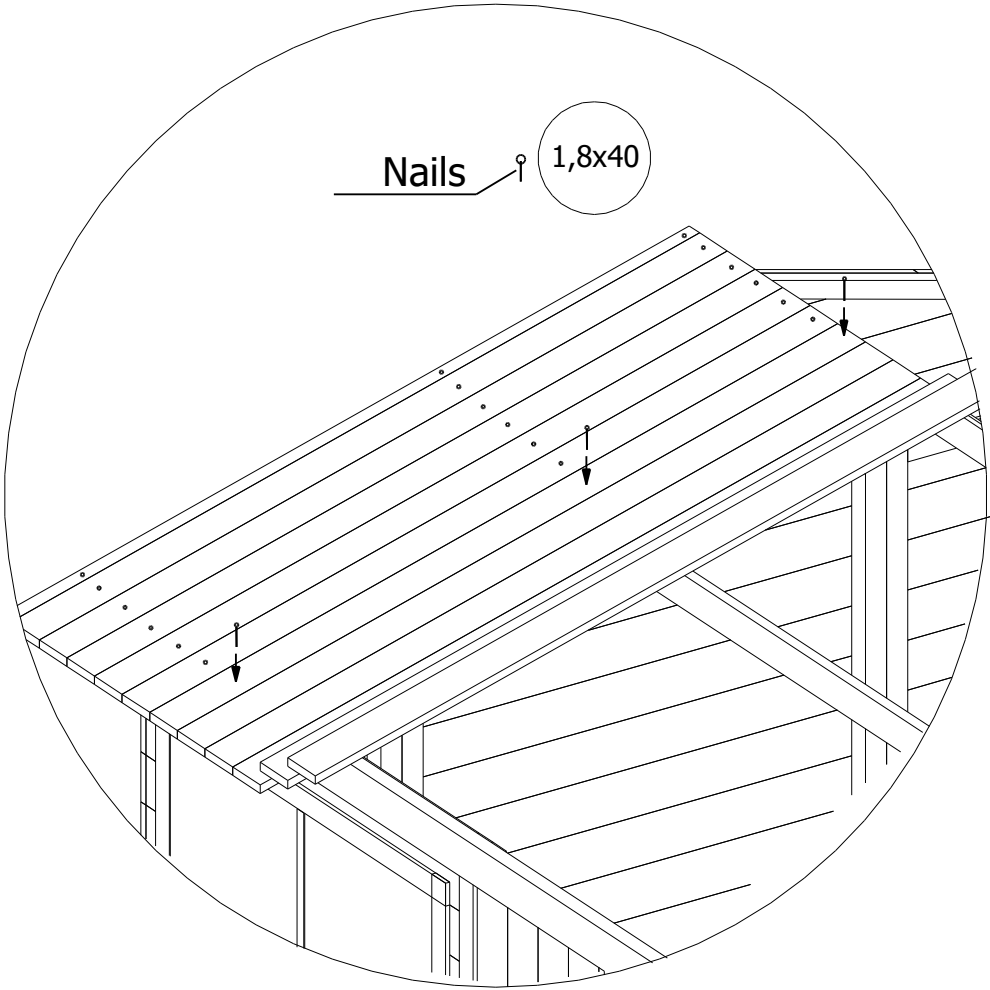
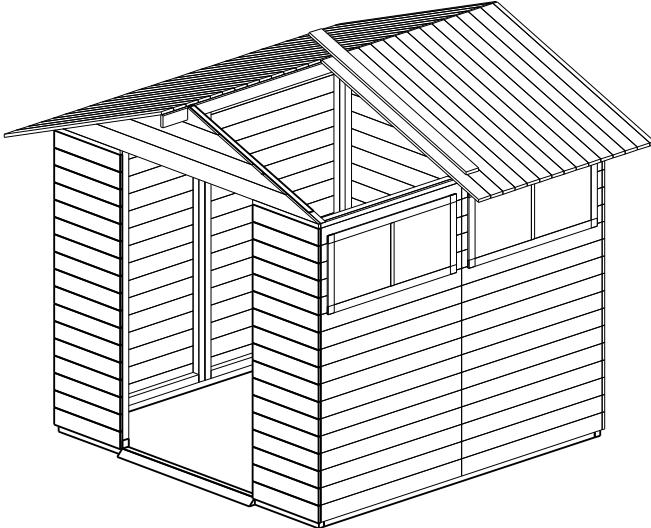
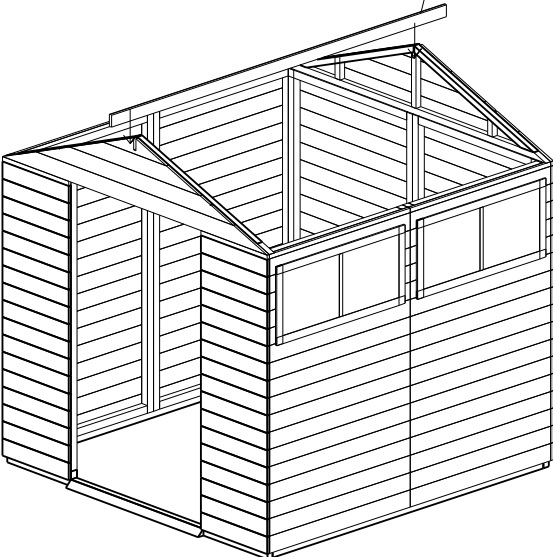

4th step Door assembly

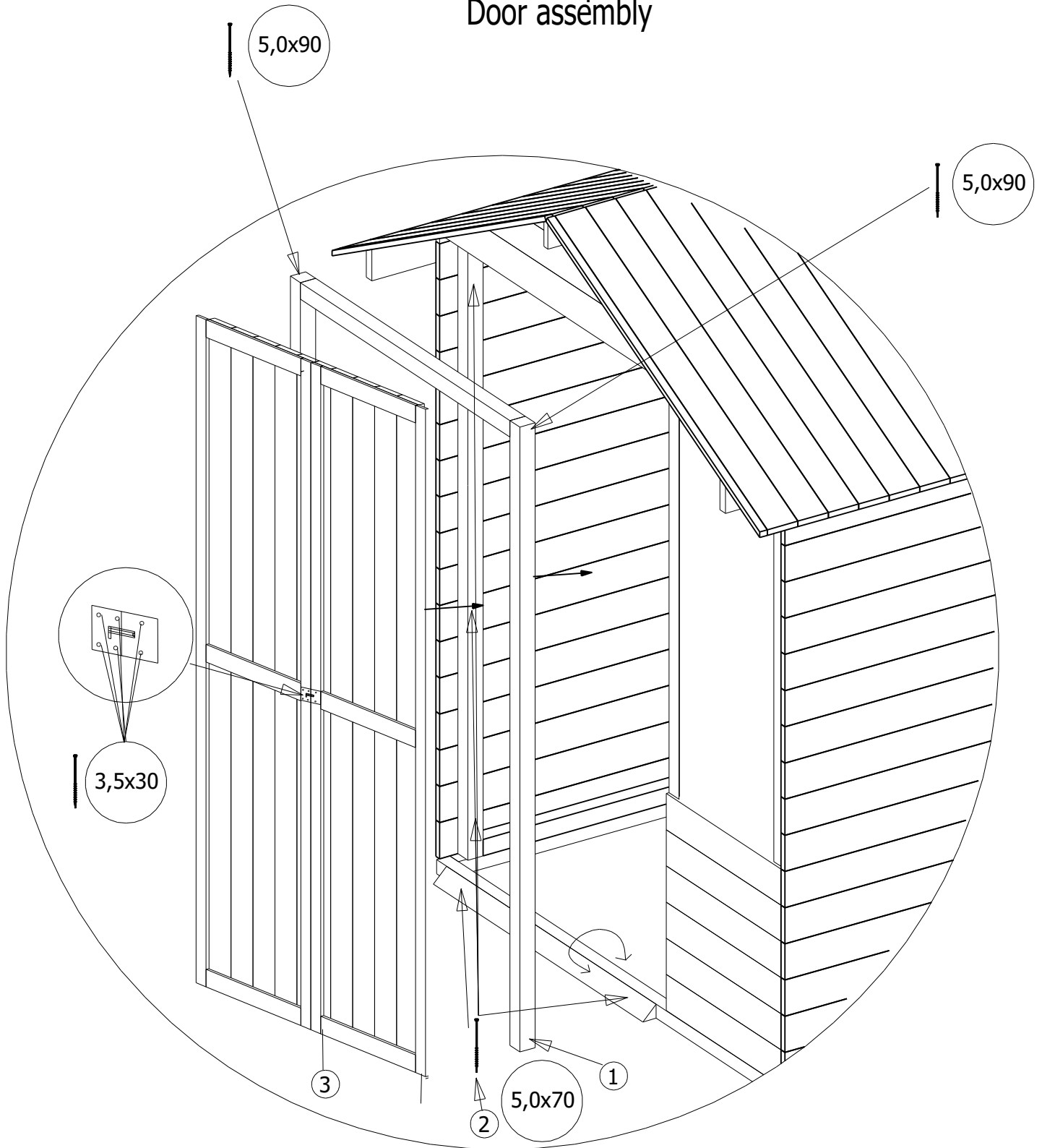

5th step Wind boards assembly

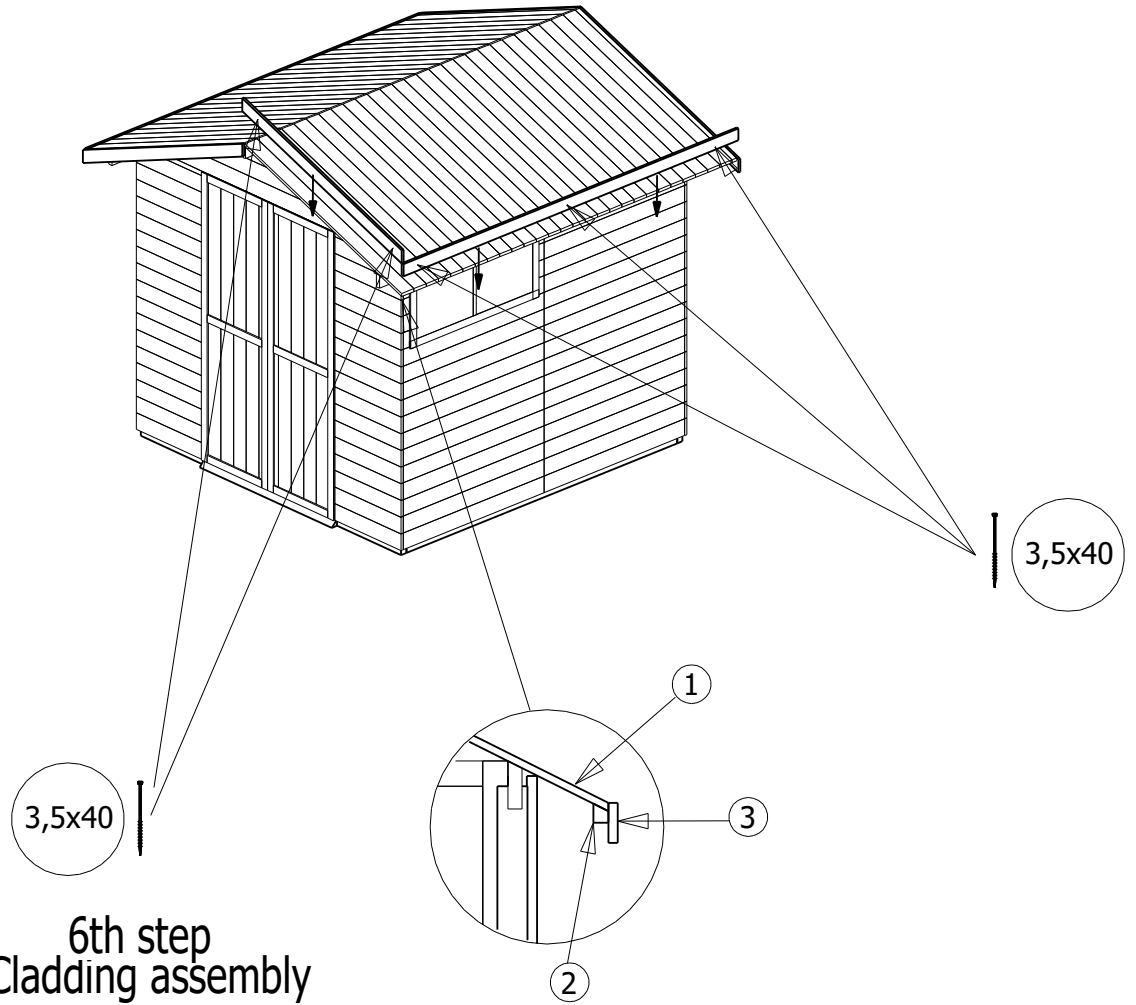

6th step Cladding assembly

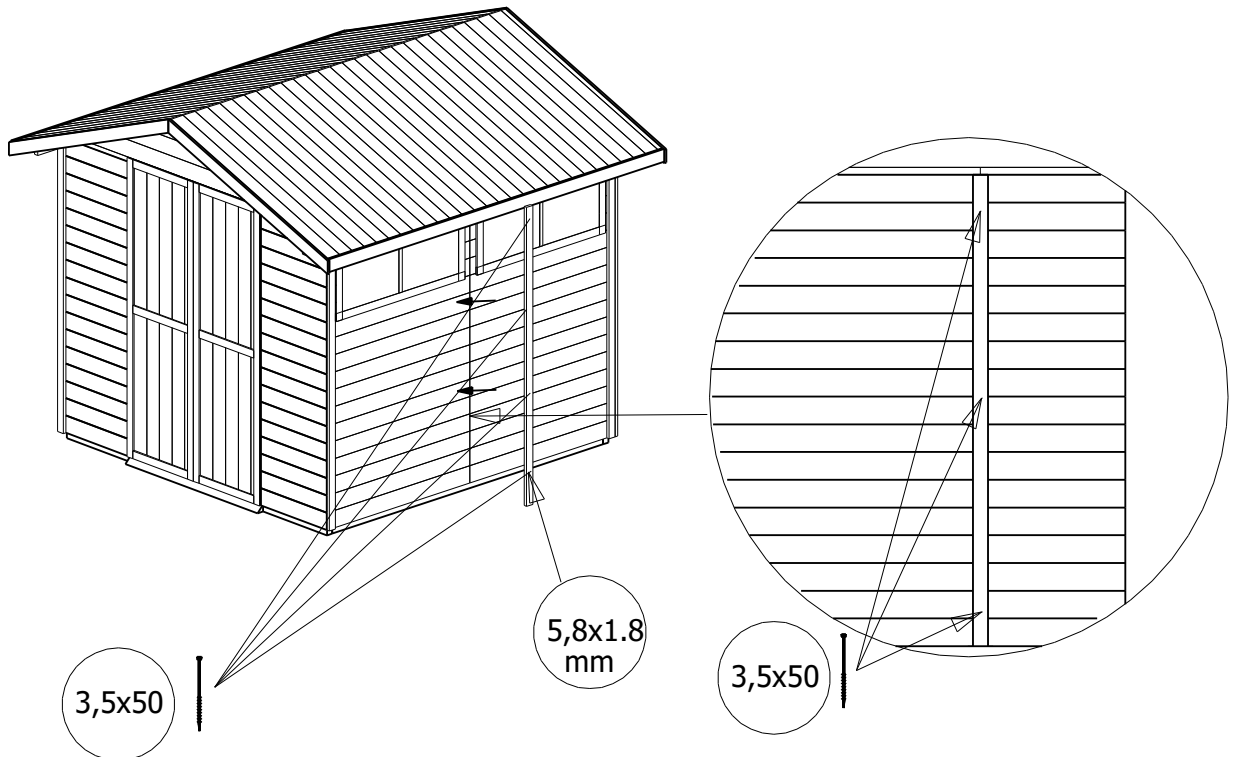

In delivery package will be:

5x70- 76 screw units

5x90- 6 screw units

1.8x40- 130 nail units

3.5x40- 42 screw units

1-Door loop

3.5x30- 6 screw units

3.5x50- 45 screw units