

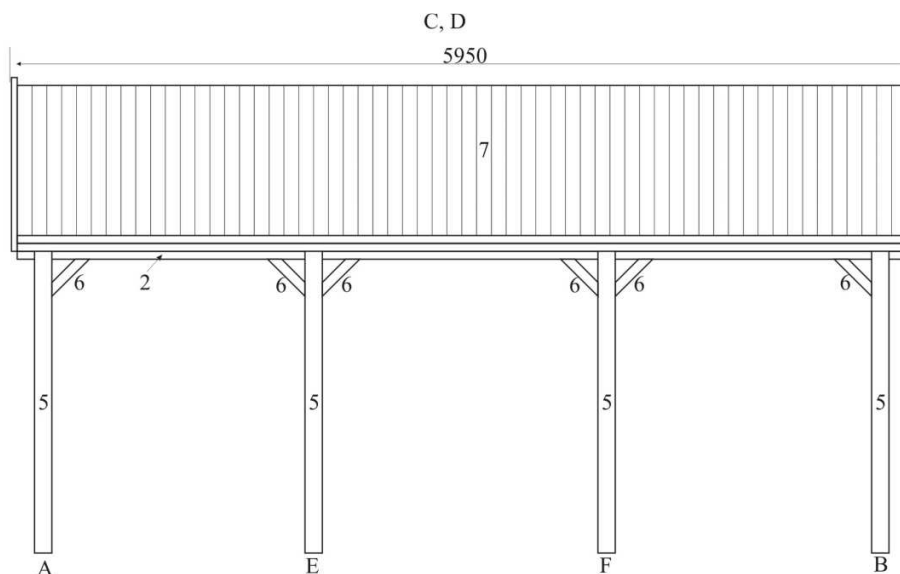

# Carport 6m x 6m Installation Plans

Carport 6 x 6						
	Size, mm			Detail stock	Details	Annotation
	Length	Width	Table			
1	5950	130	44	4		Vaults
2	5950	130	44	2		Wall C D
3	5950	130	44	1		Rafters
4	5950	130	44	4		Rafters
5	2100	130	60	8		Support boards
6	600	130	60	20		Support boards
7	3200	110	18	110		Roof boards
8	3300	105	22	4		Wind boards
9	3325	105	22	4		Wind boards
10	3325	60	16	4		Wind boards borders
11	5950	105	22	2		Roof plank
12	5950	35	25	2		Roof plank borders

## 1. The plans



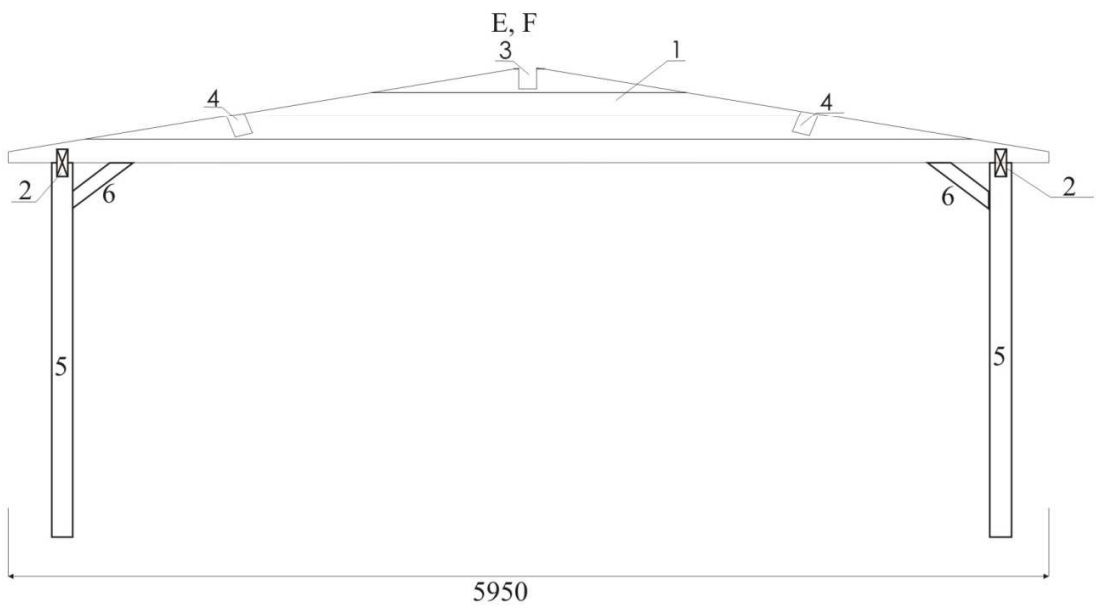
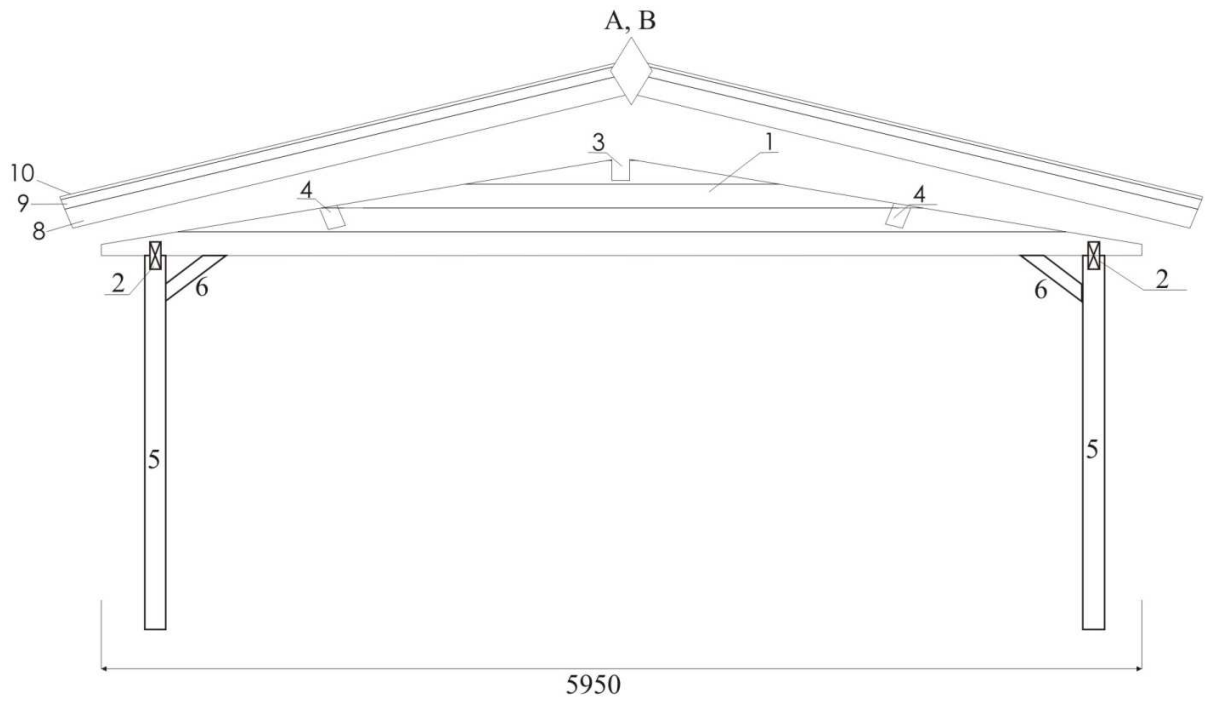

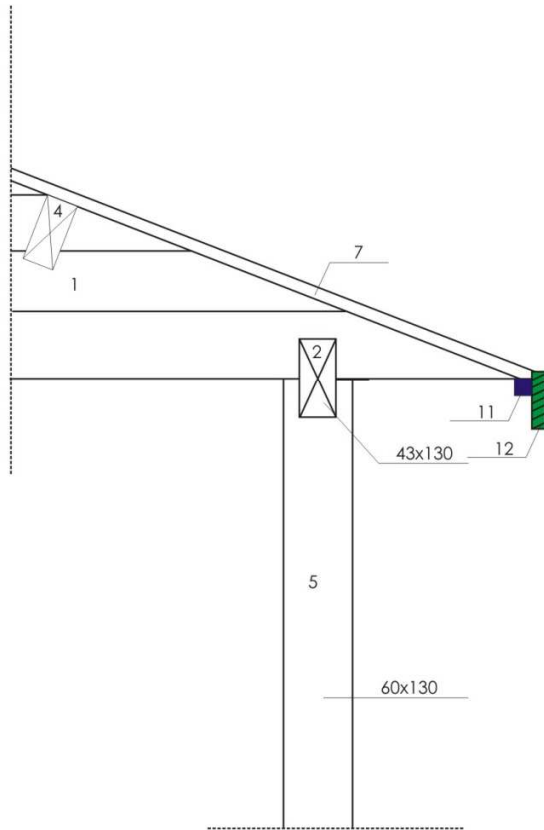
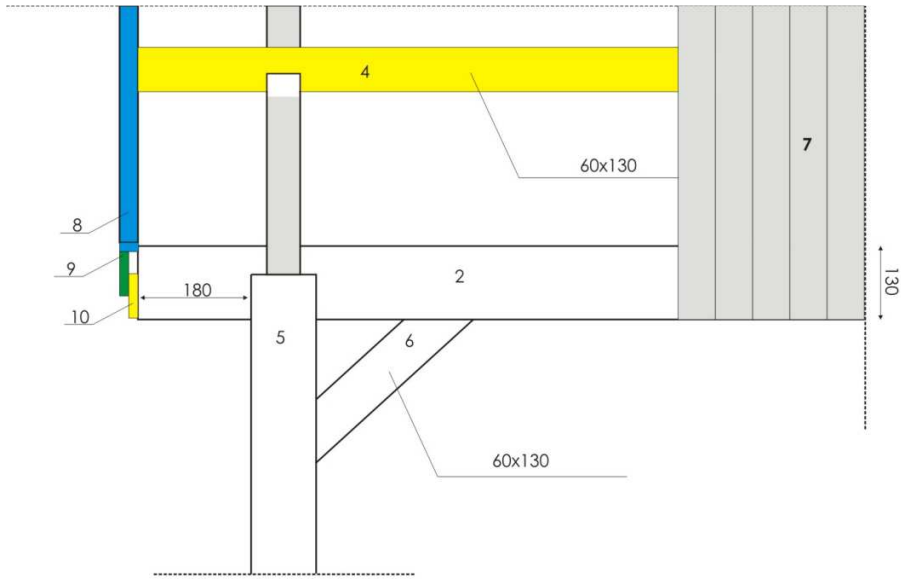

## 2. The roof

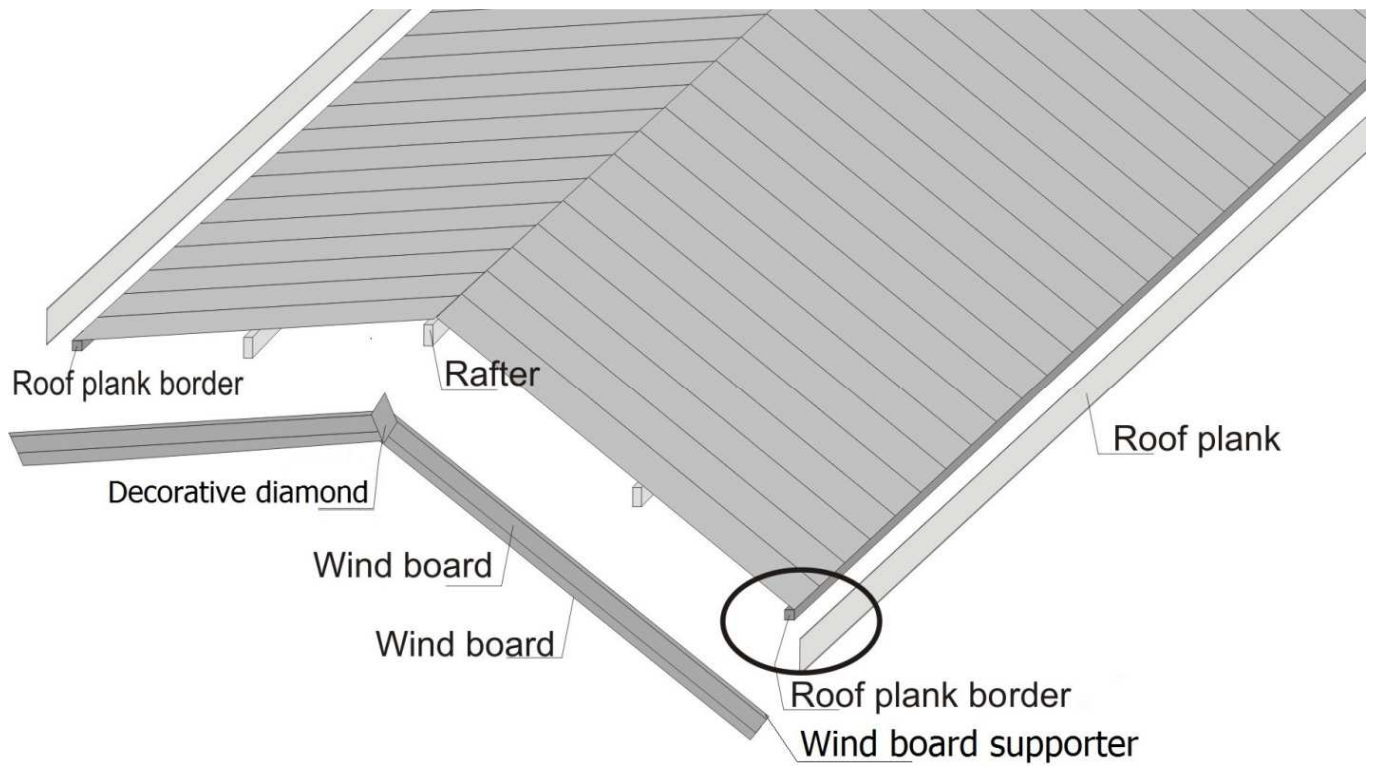
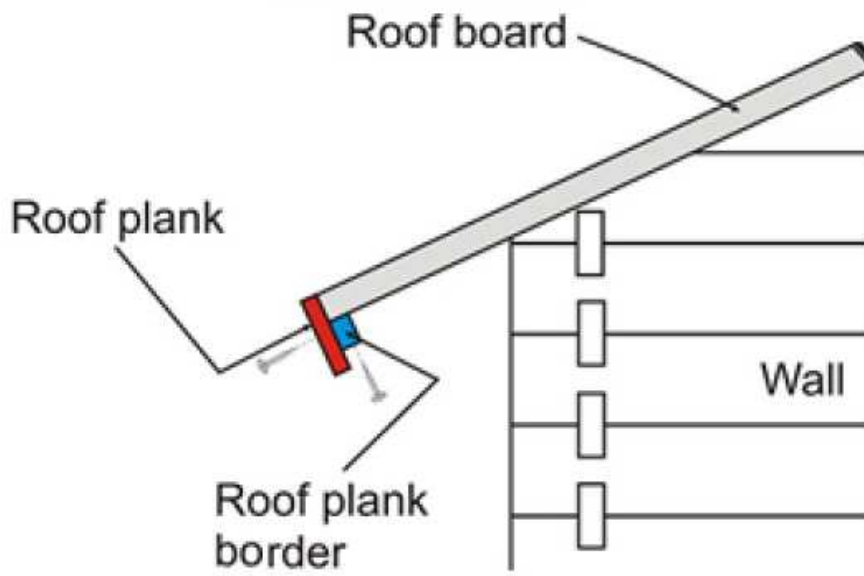

### 3. Felt roof shingles

